

Interactive Stereoscopic Display for Three or More Users

Yoshifumi Kitamura Takashige Konishi* Sumihiko Yamamoto Fumio Kishino

Osaka University

Abstract

An ideal stereoscopic display system for multiple users is proposed. It allows three or more people to simultaneously observe individual stereoscopic image pairs from their own viewpoints. The system tracks the head positions of all of the users and generates distortion-free images for each eye of each user. The system consists of a normal display and a display mask, which has a hole in its center. The display mask is placed over the display surface at a suitable distance from it. By controlling the position of the image drawing area for each user according to the corresponding user's viewpoint, each user can observe the stereoscopic image pairs shown in an individual area of the display system with shutter glasses. On the other hand, no user is able to see the image drawing areas of the other users because these areas are adequately occluded by the display mask. Accordingly, the display system can simultaneously provide intelligible 3D stereoscopic images for three or more moving observers without flicker or distortion.

CR Categories: B.4.2 [Input/Output and Data Communications]: Input/Output Devices, I.3.7 [Computer Graphics]: Three-Dimensional Graphics and Realism

Keywords: Interactive, 3D display, multiple users, motion parallax, without flicker, without distortion, visualization, collaborative work

1. Introduction

In everyday life, we often work together with several people to perform tasks effectively. Doing this while standing or sitting around a computer display monitor is one way to accelerate the exchange of ideas. Recently, 3D images have been increasingly used in such situations to show complicated 3D information intelligibly. For example, in engineering or industrial design and evaluation, medical diagnosis and training, and surgery planning, it is common for several people to exchange their ideas in front of a computer display monitor.

3D images must be provided adequately to all users at their own

Graduate School of Engineering, Osaka University, Osaka, 565-0871 Japan, kitamura@eie.eng.osaka-u.ac.jp.

* currently with Toppan Printing Co., Ltd.

Permission to make digital or hard copies of all or part of this work for personal or classroom use is granted without fee provided that copies are not made or distributed for profit or commercial advantage and that copies bear this notice and the full citation on the first page. To copy otherwise, to republish, to post on servers or to redistribute to lists, requires prior specific permission and/or a fee.

ACM SIGGRAPH 2001, 12-17 August 2001, Los Angeles, CA, USA
© 2001 ACM 1-58113-374-X/01/08...\$5.00

viewpoints as well as motion parallax. Holography is an ideal method for presenting perfect autostereoscopic images to all users by exploiting human spatial/perceptual abilities [1]. However, it is still difficult to display realistic images dynamically generated by computers in real time [2]. Because of this, stereoscopic images have been increasingly used to show 3D images by presenting a pair of images, that is, one for each eye. A user's viewpoint is usually measured and this enables him/her to observe adequate 3D images even if he/she interactively moves [3, 4]. However, one requirement is for stereoscopic images displayed on a monitor to be presented adequately to all users even if they all interactively move at the same time. Head-mounted displays (HMDs) with head trackers to provide private stereoscopic images for all individual participants might be one solution to meet this requirement. However, the workspace would not be naturally shared by all of the participants because it would be cut into pieces immediately in front of their eyes by the HMDs.

We propose a novel interactive stereoscopic display system for multiple users. The system, named IllusionHole, allows three or more moving observers to simultaneously observe individual stereoscopic image pairs from their own viewpoints. It provides intelligible 3D stereoscopic images that are free of flicker and distortion by using a simple configuration.

2. Interactive Stereoscopic Display for Multiple Users

In an interactive stereoscopic display for multiple users, the stereoscopic images have to be presented to all users according to their individual viewpoints and also give a sensation of motion parallax. For example, let us suppose a user (A) is standing right in front of the display and is observing a side view of a car. In this situation, a user (B) standing to the right of the display (or user A after moving to position B) would observe the right side of the car. At the same time, a user (C) standing to the left of the display (or user A after moving to position C) would observe the left side of the car. In order to present an adequate view to each user according to his/her position, the stereoscopic images would have to be presented by using pairs of images taken from this viewpoint or by projecting a 3D object shape model to the image plane corresponding to the user's viewpoint measured by a tracker. If multiple users shared the display, the stereoscopic images to all of the users at different positions would have to be presented simultaneously.

Another important consideration for an interactive stereoscopic display for multiple users is distortion. For example, suppose an image is presented to a user (A) standing right in front of the display. In this situation, a user (B) standing to the right of the display (or user A after moving to position B) has to observe a distorted user (A) image because he/she is looking at it from an

inclined position. In order to present a non-distorted image to user B's position, the presented images have to be revised according to the viewpoint of user B. Naturally, if these revised images were observed by a user at position A, he/she would observe a distorted image. In order to present an adequate image to each user according to his/her position, the stereoscopic images have to be revised to remove distortion according to the viewpoint of the user measured by a tracker. Again, if the display were shared by multiple users, adequate stereoscopic images to all users standing at different positions would have to be presented simultaneously.

An interactive stereoscopic display that allows a single moving user to observe a pair of stereoscopic images from his/her own viewpoint without distortion is widely used in conventional virtual reality systems by using shutter glasses operating at the image alteration rate (e.g., [5-8]). In such systems, the primary user whose viewpoint is tracked can observe adequate stereoscopic images with motion parallax and without distortion. However, secondary users must observe distorted stereoscopic images without motion parallax. In order to provide adequate stereoscopic images for multiple moving users, the display system must be equipped with the ability to present multiple pairs of stereoscopic images simultaneously.

In order for two users to observe individual stereoscopic image pairs, two pairs of stereoscopic images (four different images) must be presented, and this is achieved by using four different frame buffers [9, 10]. Four different images are presented sequentially at 1/4 the display refresh rate and shutter glasses are operated at this image alteration rate. Actually, the image for each eye alternates at 30 Hz with an ordinary display hardware having the maximum refresh rate at 120 Hz. Although this is a reasonable approach, it is clear that the user will observe noticeable flicker when the number of users increases, and the image alteration rate will become $f_{max} / (2 \cdot n_{users})$ for each eye of each user, where f_{max} is the maximum refresh rate of display and n_{users} is the number of users. Another approach to simultaneously providing two pairs of stereoscopic images to two users is to independently use two different projectors [11]. The images presented by the projectors are projected on the same display screen. Each user observes a pair of stereoscopic images presented by his/her individual projector. Although this approach can avoid the occurrence of flicker, the necessary optical hardware becomes complicated and large-scale when the number of users increases.

We propose an interactive stereoscopic display system for three or more users based on a different approach. The details are described in the following sections.

3. Design of Interactive Display for Three or More Users

The IllusionHole display system consists of a normal display and a display mask, which has a hole in its center (Fig. 1(a)). The display mask is placed over the display surface at a suitable distance. By controlling the position of the image drawing area for each user according to his/her viewpoint, each user can observe the stereoscopic image pairs shown in an individual area of the display system. On the other hand, no user is able to see the image drawing areas of the other users because the display mask adequately occludes these areas. Figure 1(b) shows an example in which three users simultaneously observe a virtual object.

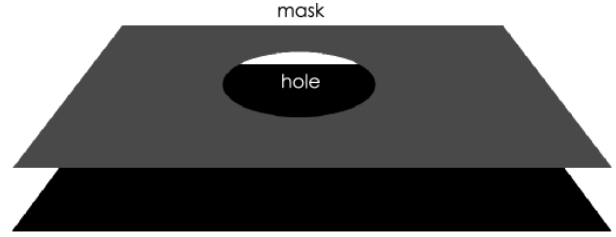

(a) Display mask and display.

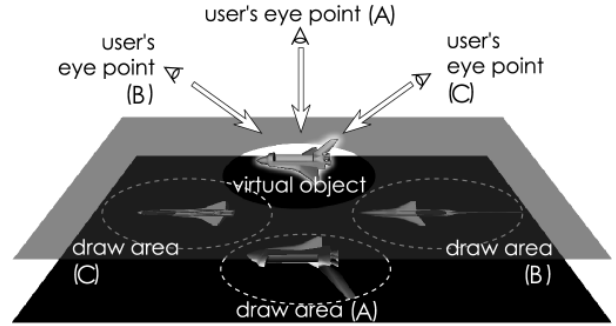

(b) Image drawing areas for individual users.

Figure 1: Configuration of IllusionHole.

The position of the image drawing area for each user is derived from two parameters, i.e., the user's viewpoint in the display coordinate system $(x_{eye}, y_{eye}, z_{eye})$ and the distance between the display surface and the mask D . By using the display coordinate system shown in Fig. 2(a), the center of the image drawing area $(x_{center}, y_{center}, z_{center})$ is given by Eq. (1) (Fig. 2(b)).

$$\begin{aligned} x_{center} &= -x_{eye} \cdot \frac{D}{z_{eye} - D} \\ y_{center} &= -y_{eye} \cdot \frac{D}{z_{eye} - D} \\ z_{center} &= 0 \end{aligned} \quad (1)$$

Here, the image drawing area becomes circular if the hole of the mask is circular. The radius of the image drawing area r is determined by three parameters, i.e., the height of the user's viewpoint z_{eye} , the distance between the display surface and the mask D , and the hole radius of the mask R , as Eq. (2) shows.

$$r = R \cdot \frac{z_{eye}}{z_{eye} - D} \quad (2)$$

Equations 1 and 2 dynamically determine the image drawing area for each user, and then the stereoscopic image pair is shown in the individual area without distortion. For example, image drawing area A in Fig. 1(b), which is derived from user A's viewpoint, is an area for showing the stereoscopic images for user A to user A alone. The other users (B and C) are unable to see this image drawing area because the display mask adequately occludes this area. On the other hand, user A is unable to see the image drawing areas of users B and C because the display mask adequately occludes these areas. If a user moves his/her head, the image drawing area corresponding to the user also moves according to the motion of the viewpoint. Therefore, users can always observe

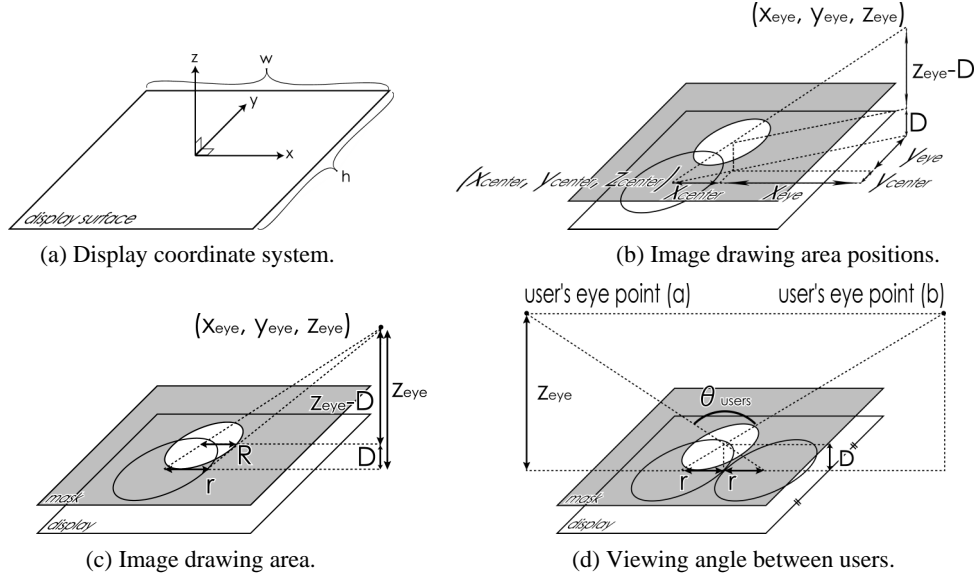

Figure 2: Geometries of IllusionHole

stereoscopic images without distortion in their own individual image drawing areas even if they move around the IllusionHole display system.

Each user has his/her individual image drawing area, so he/she can observe his/her own stereoscopic image pair even if the number of users increases. Here, a graphics computer generates the images for each eye of all users at an ordinary constant rate (e.g., 60 Hz per eye) even if the number of users increases. Accordingly, the IllusionHole display system provides intelligible 3D stereoscopic images for three or more moving observers simultaneously without flicker or distortion.

4. Trade-off Relationship among Design Parameters

IllusionHole allows three or more users to observe stereoscopic images without flicker or distortion even if they move around the display system. Here, the basic design parameters to determine the configuration of the IllusionHole display system are the size of display surface $h \times w$, the distance between the display surface and the mask D , and the radius of the mask hole R . These three parameters share a trade-off relationship, so the system must be designed to satisfy the following conditions.

- The image drawing area of a user does not exceed the boundary of the display surface.
- The valid height of a user's observable space is lower than the assumed height of the user's viewpoint at standing posture.
- The image drawing areas of users do not overlap each other.

For example, if the distance between the display surface and the mask becomes longer, the image drawing area of a user easily exceeds the boundary of the display surface. On the other hand, if the distance between the display surface and the mask becomes shorter, the image drawing areas of users easily overlap each other.

A larger hole in the display mask enables users to observe larger virtual images using larger display surface. However, the image drawing area of a user easily exceeds the boundary of the display

surface, and moreover, the image drawing areas of multiple users easily overlap each other. On the other hand, if a smaller hole of the display mask is used, the virtual images presented to the user become smaller. However, the image drawing area of a user does not easily exceed the boundary of the display surface, and moreover, the image drawing areas of multiple users do not easily overlap each other.

Four guidelines are established to evaluate the IllusionHole display configuration, and this section describes how these change according to the employed combinations of basic design parameters.

4.1 Movable Volume for a User

A larger movable volume provides a user with flexible observation of stereoscopic images because it allows him/her to move around and change viewpoints in a larger space as he/she wants. Figure 4 shows the image drawing area on the display surface. Because the image drawing area must be inside the display surface without exceeding its boundary, the diameter of the image drawing area $2r$ is set so that it does not exceed the shorter side length of the display h ; therefore, $2r \leq h$ must be satisfied. From the relationship in Fig. 2(c), the constraint on the height of a user's viewpoint is derived from equation (2) as shown by inequality (3).

$$z_{eye} \geq \frac{h \cdot D}{h - 2R} \quad (3)$$

For the constraint on the position of x_{center} and y_{center} , inequalities (4) are derived.

$$\begin{aligned} -\frac{w}{2} + r \leq x_{center} \leq \frac{w}{2} - r \\ -\frac{h}{2} + r \leq y_{center} \leq \frac{h}{2} - r \end{aligned} \quad (4)$$

This is then changed to inequality (5) by using equation (1) and inequality (3).

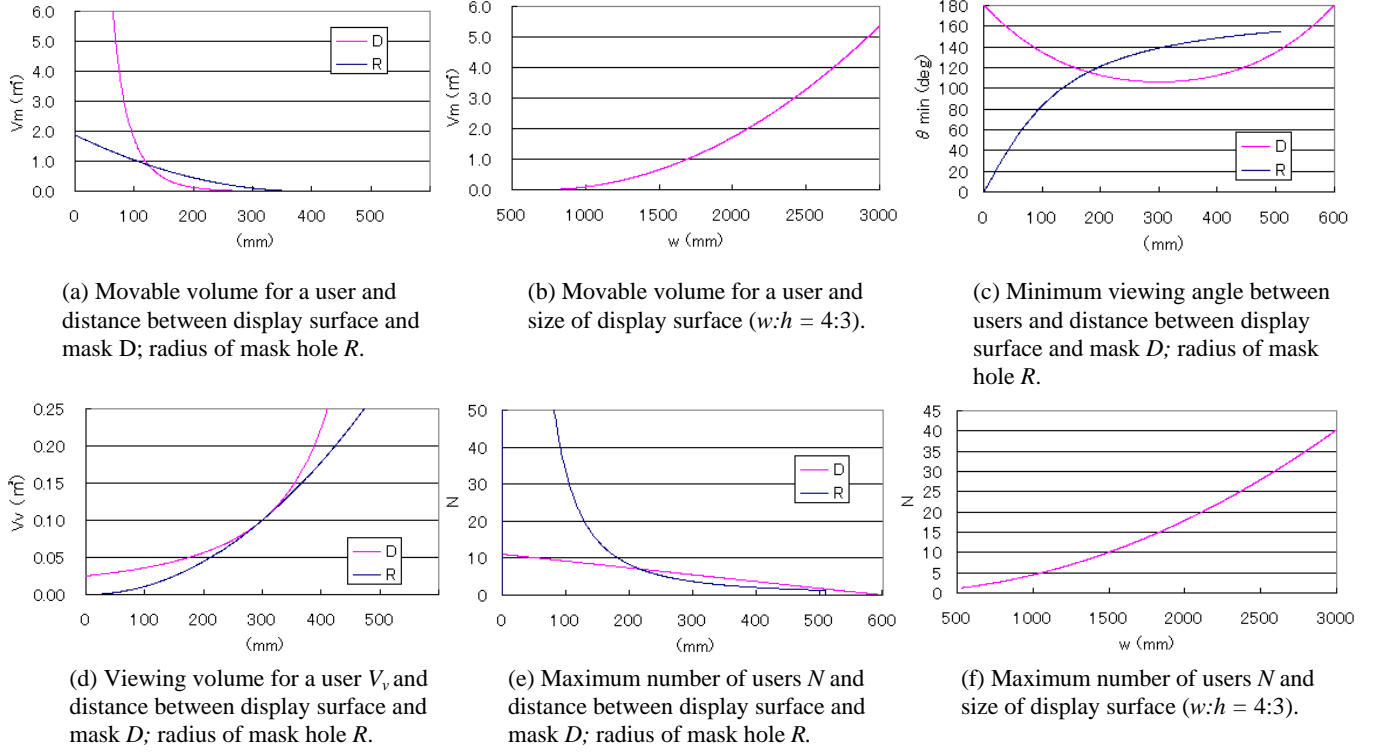

Figure 3: Trade-off relationship among design parameters.

$$z_{eye} \geq \frac{(2|x_{eye}| + w) \cdot D}{w - 2R} \quad (5)$$

$$z_{eye} \geq \frac{(2|y_{eye}| + h) \cdot D}{h - 2R}$$

The height of the user's viewpoint z_{eye} does not exceed the assumed user's viewpoint at standing posture z_{max} , so $z_{eye} \leq z_{max}$ must be satisfied. Finally, the movable volume for a user V_m where a user can observe adequate stereoscopic image satisfying above conditions is given by equation (6).

$$V_m = \frac{(w - 2R)(h - 2R)}{3D^2} \left(z_{max} + \frac{D(3R \cdot w - R \cdot h - w \cdot h)}{(w - 2R)(h - 2R)} \right) \cdot \left(z_{max} - \frac{D \cdot h}{h - 2R} \right)^2 \quad (6)$$

The movable volume for a user V_m decreases according to the distance between the display surface and the mask D or as the radius of the mask hole R increases (Fig. 3(a)). Also, V_m increases with the size of the display surface (Fig. 3(b)), where $w:h = 4:3$ is assumed.

4.2 Viewing Angle between Users

If two users' viewpoints more closely approach each other, the image drawing areas of these users can easily overlap. Therefore, the minimum angle between two users' viewing lines that avoids overlapping is one of the most important guidelines for design. A

smaller minimum viewing angle between users is required if the number of users increases. The angle between two users' viewing lines θ_{users} satisfies $\theta_{users} \geq 2 \arctan\left(\frac{r}{D}\right)$, if the two users are

located at symmetric positions against the hole of the display mask as shown in Fig. 2(d). Therefore, inequality (7) is obtained by Eq. (2).

$$\theta_{users} \geq 2 \arctan\left(\frac{R \cdot z_{eye}}{D(z_{eye} - D)}\right) \quad (7)$$

The minimum viewing angle between users θ_{min} obtained from inequality (7) varies according to the distance between the display surface and the mask D and according to the radius of the mask hole R , as shown in Fig. 3(c).

4.3 Viewing Volume for a User

Each user observes a stereoscopic image through the hole in the display mask. If a larger hole is used, a user is expected to observe a larger stereoscopic image. The viewing volume for a user V_v is given by equation (8).

$$V_v = \frac{\pi \cdot R^2 z_{eye}^3}{3(z_{eye} - D)^2} \quad (8)$$

V_v increases with the distance between the display surface and the mask D and the radius of the mask hole R , as shown in Figure 3(d).

4.4 Maximum Number of Users

The image drawing areas of multiple users may overlap each other if the number of users increases and neighboring users stand too close to one another. The constraint to avoid overlaps can be analyzed according to the relative positions of the users' viewpoints and the positions of the image drawing areas, but the sum of all of the image drawing areas of all n_{user} users must be smaller than the area of the display as expressed by inequality (9), where the radii of the image drawing areas of all of the users are assumed to be equal to r .

$$\sum_{n_{users}} \pi \cdot r^2 \leq h \cdot w \quad (9)$$

The maximum number of users is derived from Eq. (2) and inequality (9) as shown in inequality (10), where all n_{user} users are assumed to occupy the same image drawing areas.

$$n_{users} \leq \frac{w \cdot h}{\pi \cdot R^2} \left(1 - \frac{D}{z_{eye}} \right) \quad (10)$$

The maximum number of users N decreases according to the distance between the display surface and the mask D or as the radius of the mask hole R increases (Fig. 3(e)). On the other hand, N increases with the size of the display surface (Fig. 3(f)), where $w:h = 4:3$ is assumed.

4.5 Design Simulations

Typical examples of simulated IllusionHole configurations ($w=1,360$ mm, $h=1,020$ mm, $R=200$ mm) with three users (red, green, and blue) when the distance between the display surface and the mask D is too long and too short are shown in Figs. 4 and 5, respectively. When the distance between the display surface and the mask D is too long ($D=250$ mm), the movable volume for each user becomes small ($V_m=0.0310$ m³) (light green area in Fig. 4(a)). Therefore, the image drawing areas for three users easily exceed the boundary of the display surface as shown in Fig. 4(b), where $\theta_{min}=108$ degrees, $V_v=0.0739$ m³, and $N=6.44$ are derived.

On the other hand, when the distance between the display surface and the mask D is too short ($D=100$ mm), the movable volume for each user becomes large ($V_m=1.77$ m³) (light green area in Fig. 5(a)). However, the image drawing areas for three users easily overlap each other as shown in Fig. 5(b), where $\theta_{min}=135$ degrees, $V_v=0.0362$ m³, and $N=9.20$ are derived.

Other examples of simulated IllusionHole configurations ($w=1,360$ mm, $h=1,020$ mm, $D=150$ mm) when the radius of the mask hole R varies are shown in Figs. 6 and 7, respectively. When R is too large ($R=350$ mm), the viewing volume for each user becomes large ($V_v=0.137$ m³) (Fig. 6(a)). However, the image drawing areas for three users easily exceed the boundary of the display surface as shown in Fig. 6(b), where $\theta_{min}=144$ degrees, $V_m=0.0174$ m³, and $N=2.70$ are derived. On the other hand, when R is too small ($R=50$ mm), the viewing volume for each user becomes small ($V_v=0.00279$ m³) (Figure 7(a)). However, the image drawing areas for three users do not easily overlap each other and do not easily exceed the boundary of the display surface as shown in Fig. 7(b), where $\theta_{min}=48.0$ degrees, $V_m=1.42$ m³, and $N=132.5$ are derived.

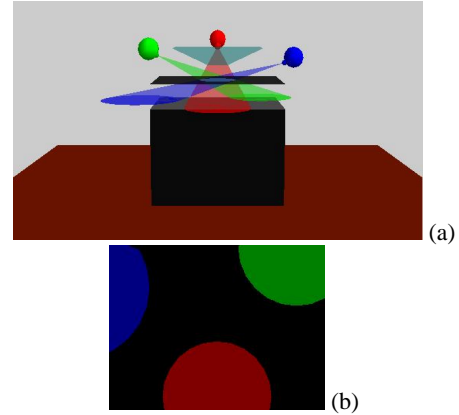

Figure 4: Example of IllusionHole configuration with three users when the distance between the display surface and mask D is too long ($D=250$ mm). (a) Movable volume for each user becomes smaller. (b) Image drawing areas for three users easily exceed the boundary of the display surface.

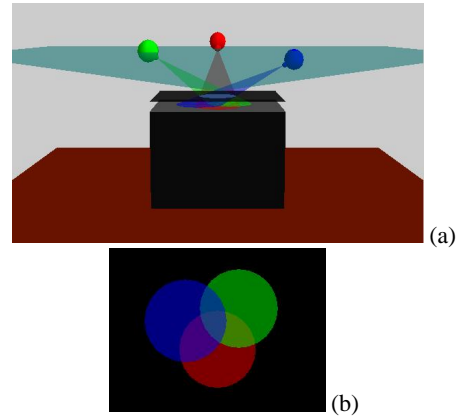

Figure 5: Example of IllusionHole configuration with three users when the distance between the display surface and mask D is too short ($D=100$ mm). (a) Viewing volume for each user becomes larger. (b) Image drawing areas for three users easily overlap each other.

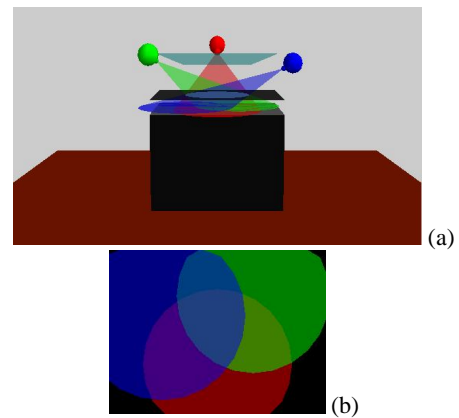

Figure 6: Example of IllusionHole configuration with three users when the radius of mask hole R is too large ($R=350$ mm). (a) Viewing volume for each user becomes larger. (b) Image drawing areas for three users easily overlap each other.

5. Illusionhole Display System

Many types of display configurations can be designed by changing the design parameters of IllusionHole. Therefore, it is important to derive a reasonable set of parameters based on human characteristics. This section first describes a typical configuration of IllusionHole using a 68-inch projection table with a horizontal display surface.

5.1 IllusionHole with Projection Table

The proposed method is implemented by using a 68-inch conventional display system, i.e., BARON (Barco), to show the effectiveness of the method as an example. The display system used in the trial system has a 1,360-mm-wide and 1,020-mm-deep display surface, and the height of the display surface from the floor is 1,000 mm. We assume that the heights of the users' viewpoints at standing postures are 1,600 mm from the floor. From the observations described in 4.5, we determine that the display mask is placed over the display surface at a distance of 150 mm; therefore, the distances from the users' viewpoints and

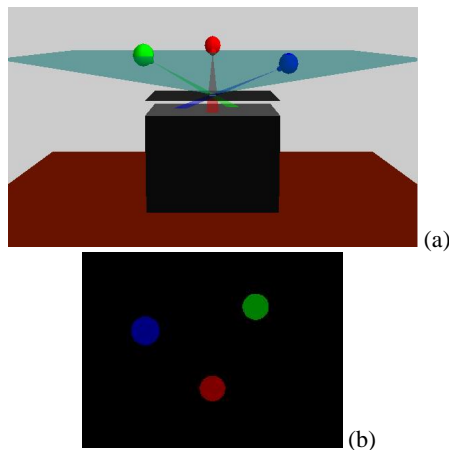

Figure 7: Example of IllusionHole configuration with three users when the radius of mask hole R is too small ($R=50$ mm). (a) Viewing volume for each user becomes smaller. (b) Image drawing areas for three users do not easily overlap each other and do not easily exceed the boundary of the display surface.

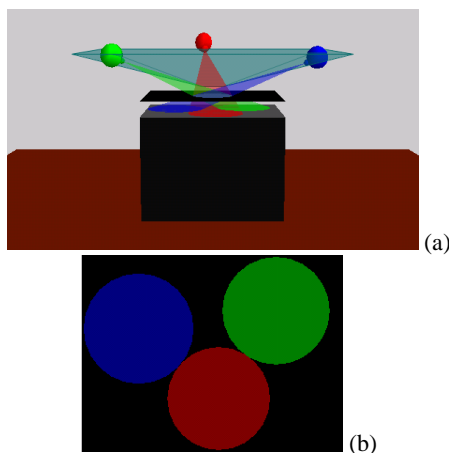

Figure 8: IllusionHole configuration with a projection table using adequate design parameters. (a) Viewing volume for each user. (b) Image drawing areas for three users.

the display surface vary from 150 mm to 600 mm in the vertical direction. The hole radius of the display mask is determined to be 200 mm so as to achieve a viewing angle of more than 120 degrees between users. The IllusionHole configuration using these design parameters with three users is shown in Figure 8.

The head position of each user is tracked by a Polhemus Fastrack, a six-DOF magnetic tracker or an Intersense IS-600 Mark 2 SoniDisc, an acoustic 3D positional tracker. Either of them is attached to LCD shutter glasses used for stereo viewing. The individual stereoscopic image pairs are generated without distortion for each eye of each person by a computer with a graphics board for OpenGL. The resolution of the stereoscopic images is 1600*588. The system configuration is shown in Fig. 9.

Sharing the IllusionHole display system among three users is described as an example. After the head positions of all of the users are measured by trackers attached to the users' heads, the positions and radii of the three image drawing areas are computed

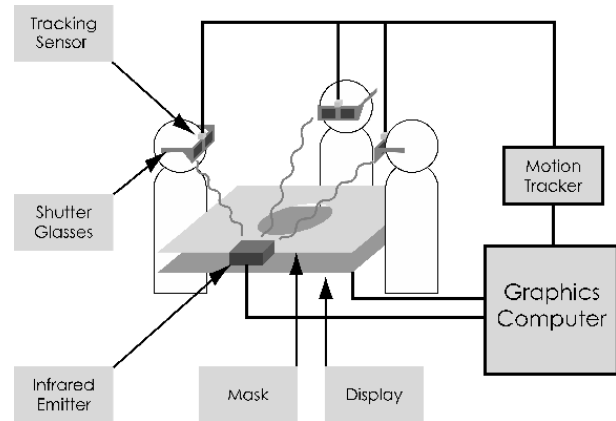

Figure 9: IllusionHole system configuration for three users.

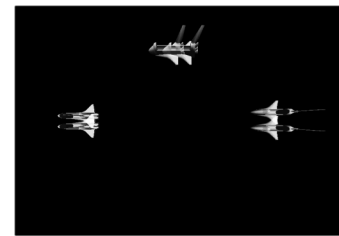

Figure 10: Stereoscopic image for three users generated by a graphics computer.

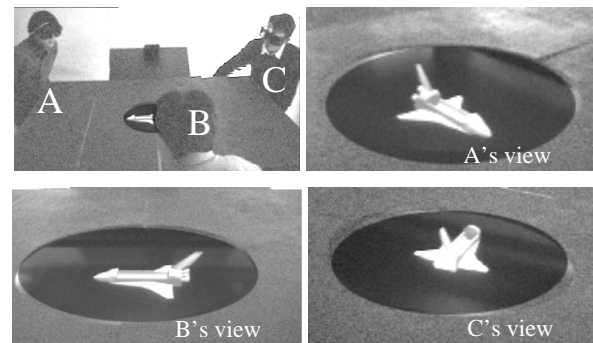

Figure 11: Example of IllusionHole shared by three users.

and the graphics computer generates pairs of stereoscopic images in the computed image drawing areas (Fig. 10). Each user observes the stereoscopic images presented in his/her individual image drawing area through the hole in the display mask. The user cannot see the images presented in the image drawing areas of the other users because the display mask adequately occludes these areas (Fig. 11).

5.2 Other Configurations

We can design many types of display configurations by changing the design parameters of IllusionHole. For example, we designed a desktop IllusionHole with a 17~21-inch PC monitor to observe individual stereoscopic images while the heads of users are together. Figure 12 shows an example of a desktop IllusionHole, where $w=400$ mm, $h=300$ mm, $R=35$ mm, and $D=150$ mm. Although the size of the display surface is small, three users (red, green, and blue) observe individual stereoscopic images with a reasonable clearance, where $\theta_{min}=35$ degrees.

On the other hand, even a theater-type IllusionHole with a very large screen can be designed in which tens of users can observe individual stereoscopic images from their own viewpoints. Figure 13 shows an example of a theater-type IllusionHole, where $w=25$ m, $h=18$ m, $R=0.5$ m, and $D=6$ m. The screen is large enough for 48 people to observe individual stereoscopic images from their own viewpoints.

Besides the stereoscopic display, which requires a pair of shutter glasses for each user for stereo viewing, the configuration of IllusionHole can be applied to interactive stereoscopic displays with other kinds of glasses such as passive polarization filters. The idea of IllusionHole can also be applied to autostereoscopic displays without glasses (e.g., [12][13]). In this study, even though the number of users of the display system is limited to

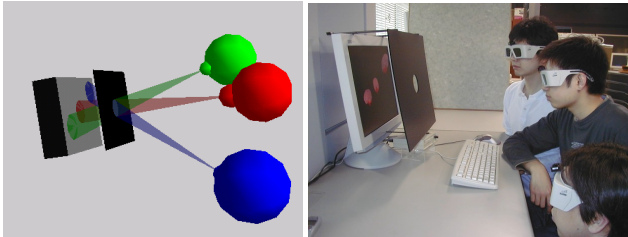

Figure 12: Configuration of desktop IllusionHole with three users. A simulated result and an actual system. ($w=400$ mm, $h=300$ mm, $R=35$ mm, and $D=150$ mm).

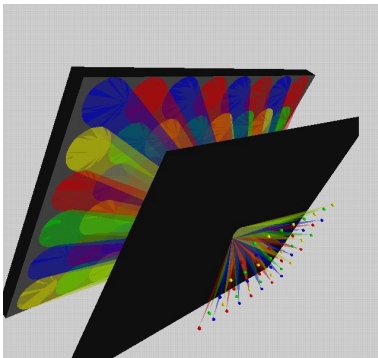

Figure 13: Configuration of theater-type IllusionHole with 48 people ($w=25$ m, $h=18$ m, $R=0.5$ m, and $D=6$ m).

only one so that adequate 3D images can be provided, the number can be increased by placing a display mask over the display surface at a suitable distance. Similar to the method described in section 3, each user can observe the stereoscopic image pairs shown in an individual area of the display system through a hole by controlling the position of the image drawing area according to the his/her viewpoint.

5.3 Discussions

One of the drawbacks of the IllusionHole is the resolution of the stereoscopic images. Even if a higher resolution image display is used, only a part of the display surface is used for each user. Actually, the image drawing area for each user is approximately 1/4 to 1/5 of the entire area of the display surface in the system used in subsection 5.1. This condition may become a limitation of the system's application; however, there are also many potential applications that can effectively exploit the substantial benefits of the IllusionHole.

The second drawback of the IllusionHole is the fact that image drawing areas of multiple users sometimes overlap each other even if the design parameters are carefully set. One solution to this problem would be to integrate image drawing areas when their corresponding viewpoints come within a certain threshold of proximity to each other.

6. Application Examples

IllusionHole is useful for applications in which several people work together to perform tasks effectively. For example, scientific visualization and medical analysis are the most feasible applications. A complicated set of data that is difficult for a single user to understand becomes a seed of discovering, training, teaching, conferencing, and communicating if it is shared by several people.

Figure 14 shows the human heart displayed on the IllusionHole. In this application example, the spiral wave reentry that is the principal mechanism of functional tachyarrhythmias is computationally simulated and visualized [12]. Figure 15 shows another example of human brain analysis using IllusionHole shared by four users. By using IllusionHole, several medical doctors can simultaneously observe the patient's heart symptoms from their own viewpoints and exchange their opinions. Consequently, it can be a powerful tool for making quick and accurate diagnoses. Figure 16 shows other application examples of interaction with virtual foods.

IllusionHole provides the 3D images for each user at exactly the same positions by showing the stereoscopic image pair with an adequate disparity for each user. Therefore, a particular point on a 3D image is observed as exactly the same point in 3D space from all users' viewpoints. For example, when a user B (C) is pointing his finger at the head (bottom) of the shuttle, the other users also recognize this pointed position as the head (bottom) of the shuttle, as shown in Figure 17, unless the finger occludes the 3D image. By utilizing this feature, IllusionHole can be applied for cooperative work in which all users share a 3D image at exactly the same position.

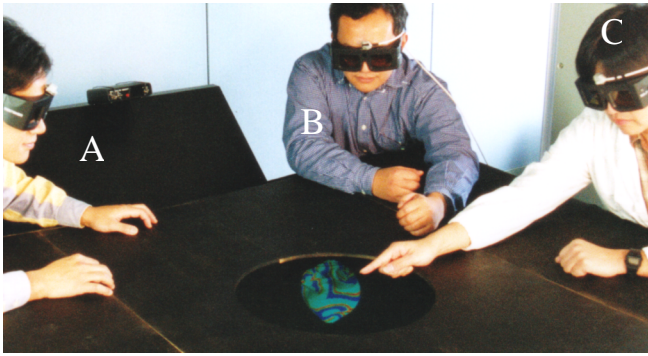

(a) The view from the fourth user's viewpoint.

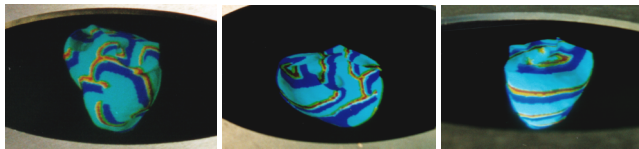

(b) User A's view (c) User B's view (d) User C's view

Figure 14: IllusionHole shared by four users. The human heart a spiral wave is computationally simulated and visualized [14].

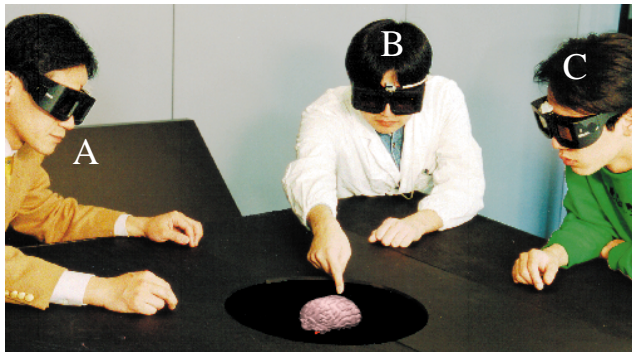

(a) The view from the fourth user's viewpoint.

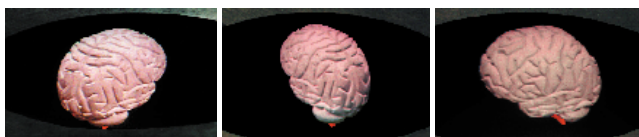

(b) User A's view (c) User B's view (d) User C's view

Figure 15: IllusionHole shared by four users. The human brain is displayed.

Another potential application is in entertainment. Although 3D stereoscopic images are often used in recent attractions at theme parks, generally not everyone in the audience can observe adequate stereoscopic images without distortion and with motion parallax. Actually, only a few people located at the right position among hundreds of people can observe adequate stereoscopic images. This drawback can be solved by IllusionHole because it provides intelligible 3D stereoscopic images for multiple moving observers simultaneously. Figure 18(a) shows an example of an attraction using carts. A person (or a group of people) riding in a cart can observe an adequate stereoscopic image at a fixed



(a) The view from the fourth user's viewpoint during an interaction with food.



(b) Close-up of a user's view.

Figure 16: Application of IllusionHole shared by four users.

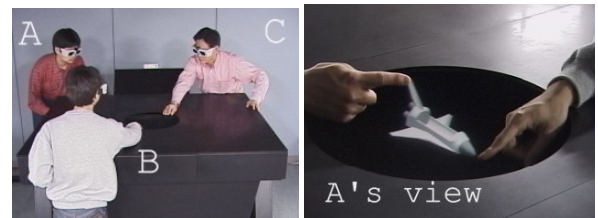

(a) (b) A's view

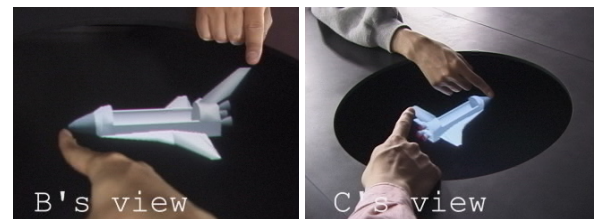

(c) (d) C's view

Figure 17: Collaboration of three users over IllusionHole.

position while moving in some direction. The same idea can be applied to a Ferris wheel or a merry-go-round. Figure 18(b) shows another example of an attraction using a center stage, where multiple audience members can observe adequate stereoscopic images while moving around a display.

The proposed method can lead to thousands of future applications in which several or more people work together to perform tasks effectively or enjoy entertainment with a multiplier effect. We imagine that possible applications include not only those listed above but also engineering design and evaluation, medical training, surgery planning, artistic work, entertainment, and so on.

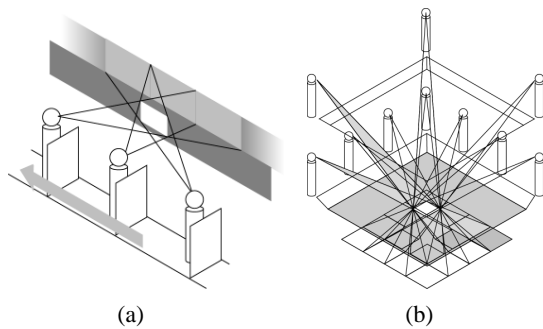

Figure 18: Example of entertainment-type attractions using (a) carts and (b) a center stage.

7. Summary and Conclusions

An interactive stereoscopic display system for multiple users, IllusionHole, was proposed. It allows three or more people to simultaneously observe individual stereoscopic image pairs from their own viewpoints by using a normal display and a display mask. It provides intelligible 3D stereoscopic images for three or more moving observers simultaneously without flicker or distortion by using a simple configuration. We showed the effectiveness of IllusionHole with a trial system having a 68-inch conventional display system. Several application examples were described. IllusionHole was shown to provide 3D images for all users at exactly the same position. The system is therefore suitable for cooperative work in the same physical space using 3D images. We also showed that the proposed method can be applied towards developing a variety of stereoscopic displays by using different sets of parameters.

Future work includes establishing cooperative work environments using IllusionHole, designing IllusionHole on an autostereoscopic display, achieving other IllusionHole configurations such as for entertainment, and so on.

Acknowledgements

We would like to thank Kazuo Nakazawa and Tohru Suzuki of the National Cardiovascular Center Research Institute for offering the human heart spiral wave simulation data in Figure 14. We would also like to thank Toshihiro Masaki, Raita Kawasaki, Shinji Fukatsu, Katsuhiko Ohnishi and the other members of the Osaka University Human Interface Engineering Lab for their useful discussions and technical support.

References

- [1] Pierre St. Hilaire, Stephen A. Benton, Mark Lucente, Mary Lou Jepsen, Joel Kollin, Hiroshi Yoshikawa, and John Underkoffler. Electronic Display System for Computational Holography. In Proceedings of SPIE, Vol. 1212, pp. 174-182, 1990.
- [2] Stephen A. Benton, Pierre St.-Hilaire, Mark Lucente, John D. Sutter, and Wendy J. Plesniak. Real-time computer-generated 3D holograms. In Proceedings of SPIE, Vol. 1983, pp. 536-543, 1993.
- [3] Larry F. Hodges. Tutorial: Time-multiplexed stereoscopic computer graphics. IEEE Computer Graphics and Applications, Vol.12, No.2, pp. 20-30, 1992.
- [4] Warren Robinett and Richard Holloway. The visual display transformation for virtual reality. Presence, Vol. 4, No. 1, pp. 1-23, 1995.
- [5] Carolina Crus-Neira, Daniel J. Sandin, and Thomas A. DeFanti. Surround-screen projection-based virtual reality: the design and implementation of the CAVE. In SIGGRAPH 93 Conference Proceedings, Annual Conference Series, pp. 135-142, 1993.
- [6] Colin Ware, Kevin Arthur, and Kellogg S. Booth. Fish tank virtual reality. In Proceedings of INTERCHI 93, pp. 37-41, 1993.
- [7] Wolfgang Kruger, Christian-A. Bohn, Bernd Frohlich, Heinrich Schuth, Wolfgang Strauss, and Gerold Wesche. The responsive workbench: a virtual work environment. IEEE Computer, pp. 42-48, July 1995.
- [8] Fumio Kishino, Tsutomu Miyasato, and Nobuyoshi Terashima. Virtual space teleconferencing - communication with realistic sensations. In Proceedings of IEEE International Workshop on Robot and Human Communication, pp. 205-210, 1995.
- [9] Maneesh Agrawala, Andrew C. Beers, Bernd Frohlich, and Pat Hanrahan. The two-user responsive workbench: support for collaboration through individual views of a shared space. In SIGGRAPH 97 Conference Proceedings, Annual Conference Series, pp. 327-332, 1997.
- [10] Tsutomu Miyasato and Ryohei Nakatsu. A study of a multi-stereoscopic display system for multi-viewers. In Proceedings of IEICE General Conference, A-16-21, 1997 (in Japanese).
- [11] Katsuyuki Omura, Shinichi Shiwa, and Fumio Kishino. Development of lenticular stereoscopic display system: multiple images for multiple viewers. In SID '95 Digest, Society of Information Display, pp. 761-764, 1995.
- [12] Graham J. Woodgate, David Ezra, Jonathan Harrold, Nicolas S. Holliman, Graham R. Jones, Richard R. Moseley. Observer tracking autostereoscopic 3D display systems. In Proceedings of SPIE, Vol. 3012, pp. 187-198, 1997.
- [13] Ken Perlin, Salvatore Paxia, Joel S. Kollin. An autostereoscopic display. In SIGGRAPH 00 Conference Proceedings, Annual Conference Series, pp. 319-326, 2000.
- [14] Kazuo Nakazawa, Tohru Suzuki, Takashi Ashihara, Masashi Inagaki, Tsunetoyo Namba, Takanori Ikeda, and Ryoji Suzuki. Computational analysis and visualization of spiral wave reentry in a virtual heart model. Takami Yamaguchi, editor, Clinical Application of Computational Mechanics to the Cardiovascular System, pp. 217-241, Springer-Verlag Tokyo, 2000.